

ウインターカップ2021

令和3年度 第74回全国高等学校バスケットボール選手権大会 岡山県予選会

令和3年10月30日(土)……山陽町ふれあい公園総合体育館(A, Bコート), 美咲町中央総合体育館(C, Dコート)

10月31日(日)……県立岡山南高等学校(Eコート), 岡山学芸館高等学校(Fコート)

11月 6日(土), 7日(日)……笠岡総合体育館(Mコート)

トーナメント表

☆試合時間

10/30(土), 10/31(日), 11/ 6(土)

1 ー① 9:30    2 二② 11:30    3 Ⅲ③ 13:30    4 Ⅳ④ 15:30

11/ 7(日)

I 9:30(女子決勝)    II 12:00(男子決勝)

【男子の部】

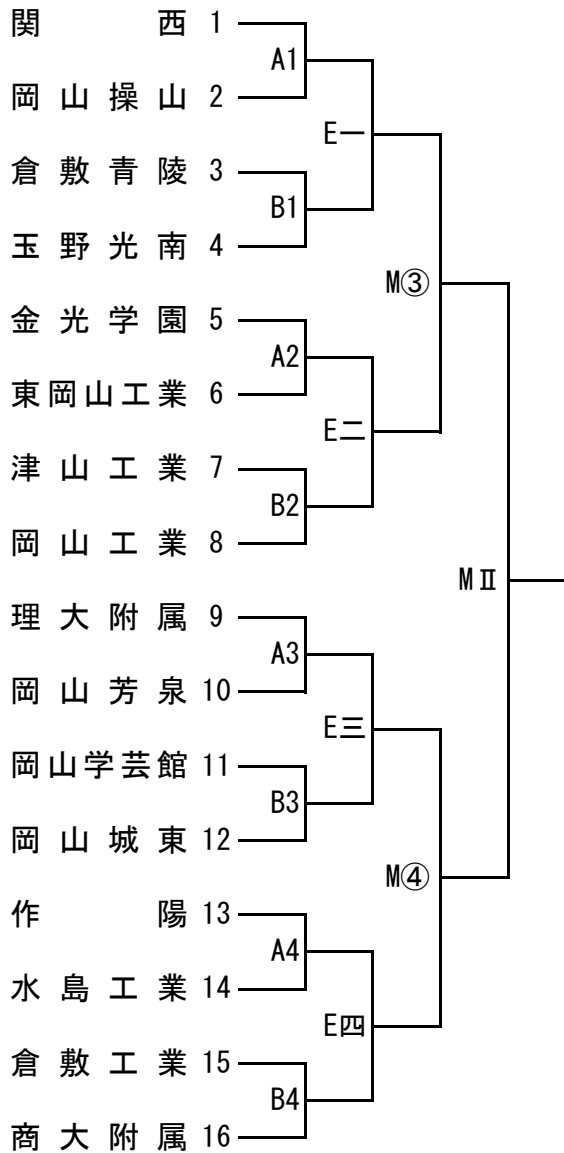

【女子の部】

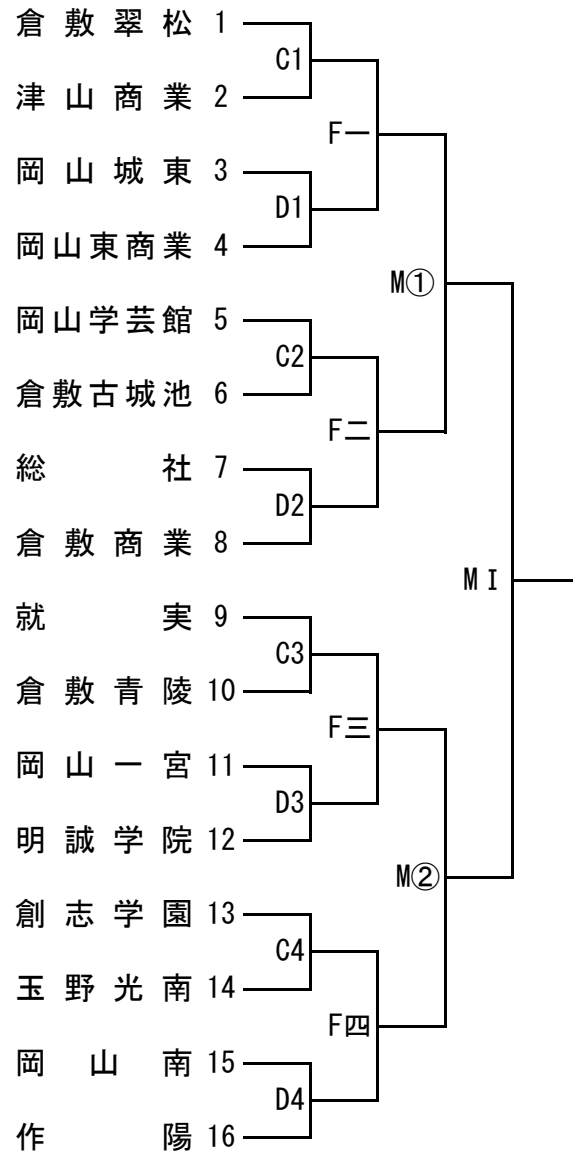

# Winter Cup2021令和3年度 第74回全国高等学校バスケットボール選手権大会

## 備前地区予選会

主催 一般社団法人岡山県バスケットボール協会・岡山県高体連バスケットボール部

期日・会場

9月18日(土) 興陽高等学校(A・Bコート)・岡山芳泉高等学校(C・Dコート)・岡山一宮高等学校(E・Fコート)  
 9月19日(日) 興陽高等学校(A・Bコート)

県予選会出場チーム

男子 関西・商大附属・理大附属・岡山工業・玉野光南・岡山城東 および  
 代表決定戦勝者(a・b・c・d) の計10チーム  
 女子 就実・明誠学院・創志学園・岡山東商業・岡山学芸館 および  
 代表決定戦勝者(a・b・c・d) の計9チーム

組合せ(男子)

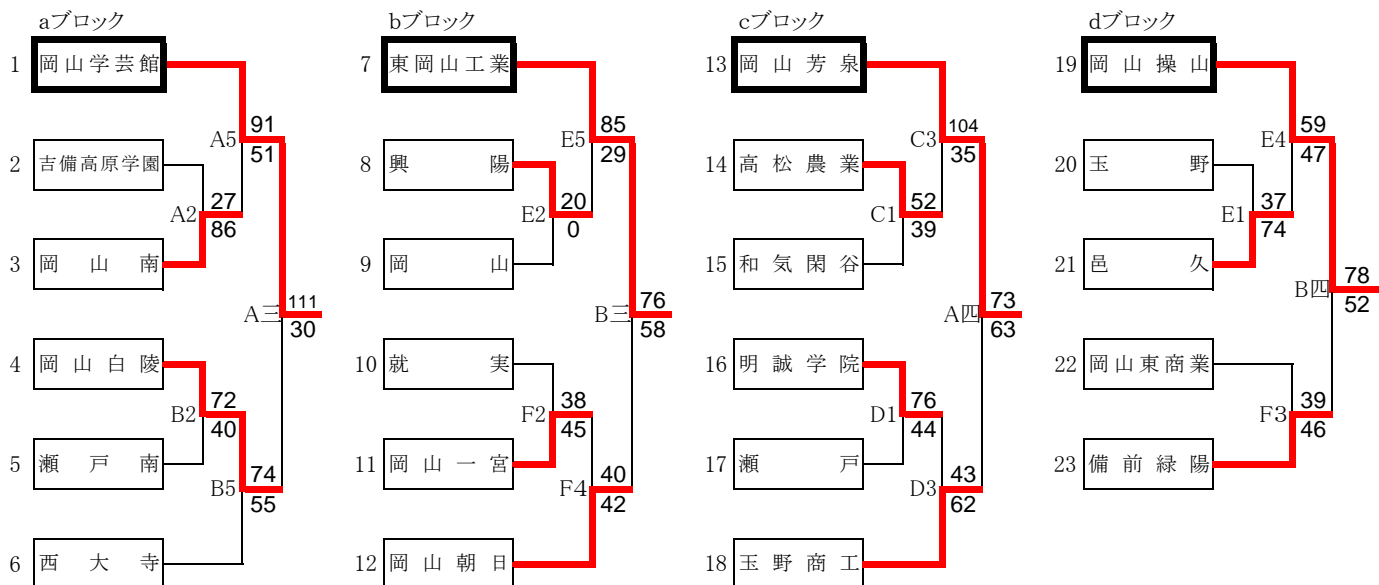

組合せ(女子)

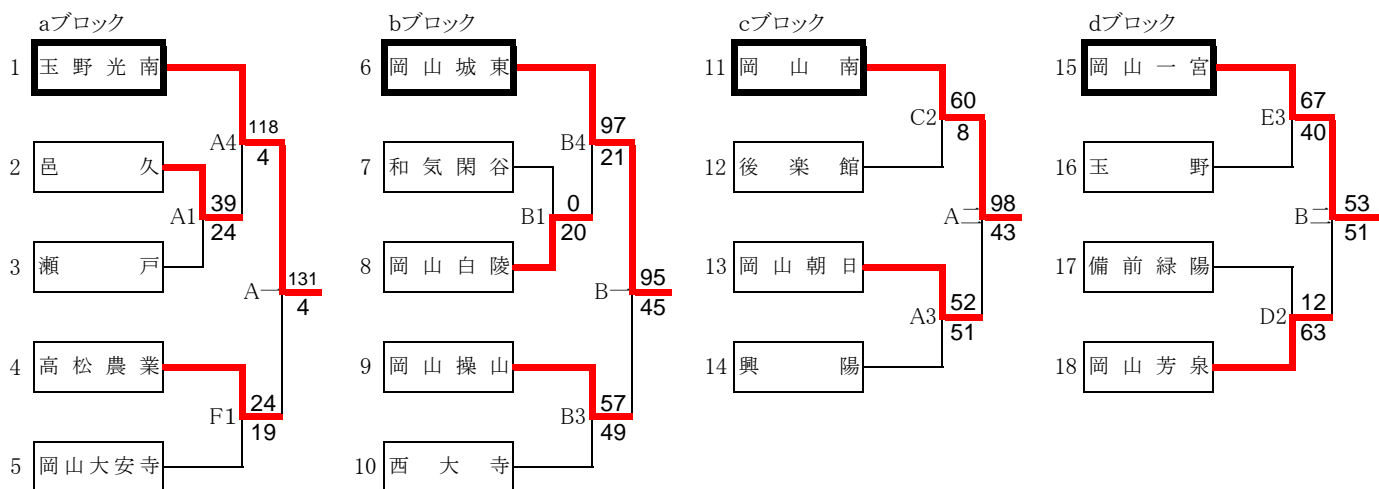

Winter Cup 2021 第74回全国高等学校バスケットボール選手権大会

岡山県予選備中地区予選会 結果

主催 (一社)岡山県バスケットボール協会・岡山県高体連バスケットボール部

日時・会場 令和3年9月18日(土) 倉敷天城高校(A・Bコート) 倉敷古城池高校(C・Dコート)  
 9月19日(日) 倉敷天城高校(A・Bコート) 倉敷古城池高校(C・Dコート)  
 倉敷鷺羽高校(E・Fコート)

組み合わせ(男子)

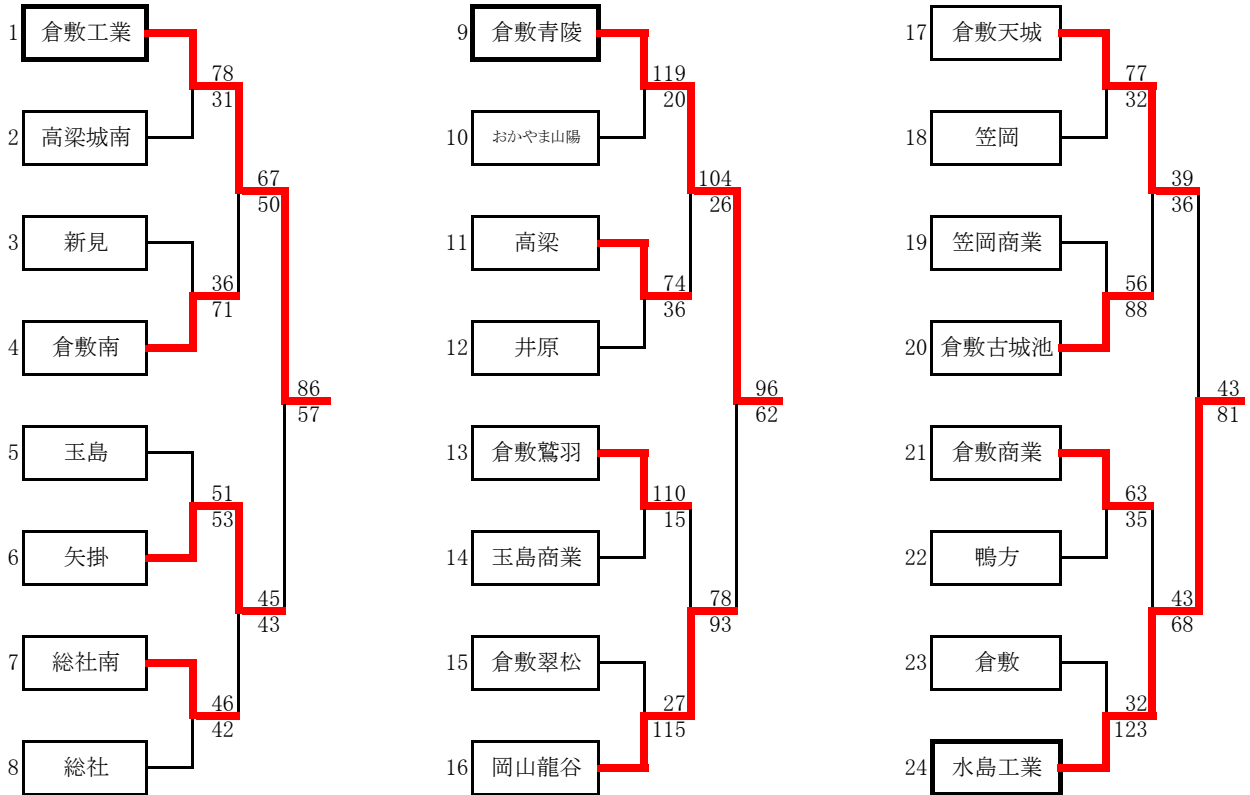

※県大会出場: 金光学園(県総体ベスト8以上)、倉敷工業、倉敷青陵、水島工業

組み合わせ(女子)

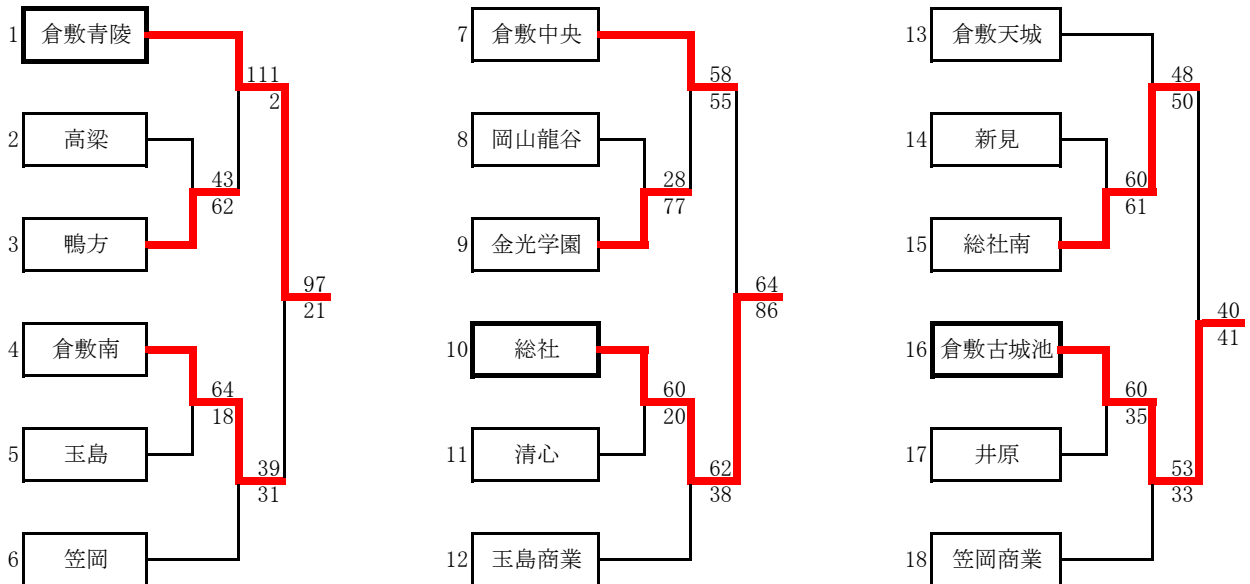

※県大会出場: 倉敷翠松、倉敷商業(県総体ベスト8以上)、倉敷青陵、総社、倉敷古城池

【男子結果】

○ 倉敷鷺羽 110	$\begin{array}{ c } \hline 27 - 3 \\ \hline 30 - 8 \\ \hline 25 - 0 \\ \hline 28 - 4 \\ \hline \end{array}$	15 玉島商業 ●	○ 倉敷南 69	$\begin{array}{ c } \hline 18 - 8 \\ \hline 21 - 7 \\ \hline 16 - 12 \\ \hline 14 - 9 \\ \hline \end{array}$	36 新見 ●	○ 矢掛 45	$\begin{array}{ c } \hline 14 - 3 \\ \hline 11 - 16 \\ \hline 12 - 10 \\ \hline 8 - 14 \\ \hline \end{array}$	43 総社南 ●	○ 倉敷工業 86	$\begin{array}{ c } \hline 21 - 15 \\ \hline 20 - 14 \\ \hline 27 - 15 \\ \hline 18 - 13 \\ \hline \end{array}$	57 矢掛 ●
● 倉敷翠松 27	$\begin{array}{ c } \hline 6 - 40 \\ \hline 13 - 21 \\ \hline 4 - 33 \\ \hline 4 - 21 \\ \hline \end{array}$	115 岡山龍谷 ○	○ 倉敷天城 77	$\begin{array}{ c } \hline 24 - 1 \\ \hline 6 - 18 \\ \hline 28 - 7 \\ \hline 19 - 6 \\ \hline \end{array}$	32 笠岡 ●	○ 倉敷天城 39	$\begin{array}{ c } \hline 12 - 10 \\ \hline 12 - 12 \\ \hline 15 - 6 \\ \hline 0 - 8 \\ \hline \end{array}$	36 倉敷古城池 ●	○ 倉敷青陵 96	$\begin{array}{ c } \hline 21 - 9 \\ \hline 18 - 18 \\ \hline 25 - 21 \\ \hline 32 - 14 \\ \hline \end{array}$	62 岡山龍谷 ●
● 玉島 51	$\begin{array}{ c } \hline 8 - 12 \\ \hline 14 - 13 \\ \hline 12 - 10 \\ \hline 17 - 18 \\ \hline \end{array}$	53 矢掛 ○	● 笠岡商業 56	$\begin{array}{ c } \hline 19 - 25 \\ \hline 16 - 16 \\ \hline 6 - 32 \\ \hline 15 - 15 \\ \hline \end{array}$	88 倉敷古城池 ○	● 倉敷商業 43	$\begin{array}{ c } \hline 15 - 19 \\ \hline 17 - 15 \\ \hline 4 - 20 \\ \hline 7 - 14 \\ \hline \end{array}$	68 水島工業 ○	○ 倉敷天城 43	$\begin{array}{ c } \hline 5 - 26 \\ \hline 10 - 11 \\ \hline 16 - 15 \\ \hline 12 - 29 \\ \hline \end{array}$	81 水島工業 ●
○ 総社南 46	$\begin{array}{ c } \hline 7 - 7 \\ \hline 15 - 12 \\ \hline 14 - 13 \\ \hline 10 - 10 \\ \hline \end{array}$	42 総社 ●	○ 倉敷商業 64	$\begin{array}{ c } \hline 16 - 3 \\ \hline 19 - 5 \\ \hline 9 - 18 \\ \hline 20 - 9 \\ \hline \end{array}$	35 鴨方 ●	○ 倉敷青陵 104	$\begin{array}{ c } \hline 29 - 2 \\ \hline 19 - 6 \\ \hline 36 - 5 \\ \hline 20 - 13 \\ \hline \end{array}$	26 高梁 ●			
○ 倉敷青陵 91	$\begin{array}{ c } \hline 22 - 9 \\ \hline 24 - 8 \\ \hline 23 - 8 \\ \hline 22 - 18 \\ \hline \end{array}$	43 おかやま山陽 ●	● 倉敷 32	$\begin{array}{ c } \hline 11 - 24 \\ \hline 7 - 28 \\ \hline 14 - 41 \\ \hline 0 - 30 \\ \hline \end{array}$	123 水島工業 ○	● 倉敷鷺羽 78	$\begin{array}{ c } \hline 17 - 36 \\ \hline 16 - 25 \\ \hline 25 - 10 \\ \hline 20 - 22 \\ \hline \end{array}$	93 岡山龍谷 ○			
○ 高梁 74	$\begin{array}{ c } \hline 19 - 5 \\ \hline 25 - 7 \\ \hline 14 - 6 \\ \hline 16 - 18 \\ \hline \end{array}$	36 井原 ●	○ 倉敷工業 67	$\begin{array}{ c } \hline 22 - 12 \\ \hline 17 - 9 \\ \hline 13 - 15 \\ \hline 15 - 14 \\ \hline \end{array}$	50 倉敷南 ●						

【女子結果】

● 高梁 43	<table border="1"> <tr><td>8</td><td>—</td><td>14</td></tr> <tr><td>13</td><td>—</td><td>25</td></tr> <tr><td>6</td><td>—</td><td>14</td></tr> <tr><td>16</td><td>—</td><td>9</td></tr> </table>	8	—	14	13	—	25	6	—	14	16	—	9	62	○ 鴨方	○ 倉敷青陵 111	<table border="1"> <tr><td>28</td><td>—</td><td>1</td></tr> <tr><td>21</td><td>—</td><td>1</td></tr> <tr><td>35</td><td>—</td><td>0</td></tr> <tr><td>27</td><td>—</td><td>0</td></tr> </table>	28	—	1	21	—	1	35	—	0	27	—	0	2	● 鴨方	○ 倉敷青陵 97	<table border="1"> <tr><td>19</td><td>—</td><td>6</td></tr> <tr><td>28</td><td>—</td><td>8</td></tr> <tr><td>24</td><td>—</td><td>3</td></tr> <tr><td>26</td><td>—</td><td>4</td></tr> </table>	19	—	6	28	—	8	24	—	3	26	—	4	21	● 倉敷南
8	—	14																																													
13	—	25																																													
6	—	14																																													
16	—	9																																													
28	—	1																																													
21	—	1																																													
35	—	0																																													
27	—	0																																													
19	—	6																																													
28	—	8																																													
24	—	3																																													
26	—	4																																													
○ 倉敷南 64	<table border="1"> <tr><td>19</td><td>—</td><td>2</td></tr> <tr><td>15</td><td>—</td><td>2</td></tr> <tr><td>13</td><td>—</td><td>3</td></tr> <tr><td>17</td><td>—</td><td>11</td></tr> </table>	19	—	2	15	—	2	13	—	3	17	—	11	18	● 玉島	○ 倉敷南 39	<table border="1"> <tr><td>10</td><td>—</td><td>4</td></tr> <tr><td>9</td><td>—</td><td>4</td></tr> <tr><td>5</td><td>—</td><td>9</td></tr> <tr><td>15</td><td>—</td><td>14</td></tr> </table>	10	—	4	9	—	4	5	—	9	15	—	14	31	● 笠岡	● 倉敷中央 64	<table border="1"> <tr><td>18</td><td>—</td><td>17</td></tr> <tr><td>16</td><td>—</td><td>21</td></tr> <tr><td>15</td><td>—</td><td>27</td></tr> <tr><td>15</td><td>—</td><td>21</td></tr> </table>	18	—	17	16	—	21	15	—	27	15	—	21	86	○ 総社
19	—	2																																													
15	—	2																																													
13	—	3																																													
17	—	11																																													
10	—	4																																													
9	—	4																																													
5	—	9																																													
15	—	14																																													
18	—	17																																													
16	—	21																																													
15	—	27																																													
15	—	21																																													
● 岡山龍谷 28	<table border="1"> <tr><td>9</td><td>—</td><td>22</td></tr> <tr><td>6</td><td>—</td><td>17</td></tr> <tr><td>6</td><td>—</td><td>17</td></tr> <tr><td>7</td><td>—</td><td>21</td></tr> </table>	9	—	22	6	—	17	6	—	17	7	—	21	77	○ 金光学園	○ 倉敷中央 58	<table border="1"> <tr><td>12</td><td>—</td><td>18</td></tr> <tr><td>17</td><td>—</td><td>13</td></tr> <tr><td>16</td><td>—</td><td>20</td></tr> <tr><td>13</td><td>—</td><td>4</td></tr> </table>	12	—	18	17	—	13	16	—	20	13	—	4	55	● 金光学園	● 総社南 40	<table border="1"> <tr><td>9</td><td>—</td><td>4</td></tr> <tr><td>15</td><td>—</td><td>10</td></tr> <tr><td>8</td><td>—</td><td>10</td></tr> <tr><td>8</td><td>—</td><td>17</td></tr> </table>	9	—	4	15	—	10	8	—	10	8	—	17	41	○ 倉敷古城池
9	—	22																																													
6	—	17																																													
6	—	17																																													
7	—	21																																													
12	—	18																																													
17	—	13																																													
16	—	20																																													
13	—	4																																													
9	—	4																																													
15	—	10																																													
8	—	10																																													
8	—	17																																													
○ 総社 60	<table border="1"> <tr><td>23</td><td>—</td><td>7</td></tr> <tr><td>11</td><td>—</td><td>6</td></tr> <tr><td>14</td><td>—</td><td>5</td></tr> <tr><td>12</td><td>—</td><td>2</td></tr> </table>	23	—	7	11	—	6	14	—	5	12	—	2	20	● 清心	○ 総社 62	<table border="1"> <tr><td>18</td><td>—</td><td>10</td></tr> <tr><td>12</td><td>—</td><td>6</td></tr> <tr><td>20</td><td>—</td><td>6</td></tr> <tr><td>12</td><td>—</td><td>16</td></tr> </table>	18	—	10	12	—	6	20	—	6	12	—	16	38	● 玉島商業																
23	—	7																																													
11	—	6																																													
14	—	5																																													
12	—	2																																													
18	—	10																																													
12	—	6																																													
20	—	6																																													
12	—	16																																													
● 新見 60	<table border="1"> <tr><td>13</td><td>—</td><td>13</td></tr> <tr><td>20</td><td>—</td><td>11</td></tr> <tr><td>12</td><td>—</td><td>14</td></tr> <tr><td>8</td><td>—</td><td>15</td></tr> <tr><td>7</td><td>—</td><td>8</td></tr> </table>	13	—	13	20	—	11	12	—	14	8	—	15	7	—	8	61	○ 総社南	● 倉敷天城 48	<table border="1"> <tr><td>11</td><td>—</td><td>12</td></tr> <tr><td>13</td><td>—</td><td>13</td></tr> <tr><td>12</td><td>—</td><td>13</td></tr> <tr><td>12</td><td>—</td><td>12</td></tr> </table>	11	—	12	13	—	13	12	—	13	12	—	12	50	○ 総社南													
13	—	13																																													
20	—	11																																													
12	—	14																																													
8	—	15																																													
7	—	8																																													
11	—	12																																													
13	—	13																																													
12	—	13																																													
12	—	12																																													
○ 倉敷古城池 60	<table border="1"> <tr><td>8</td><td>—</td><td>10</td></tr> <tr><td>23</td><td>—</td><td>8</td></tr> <tr><td>17</td><td>—</td><td>7</td></tr> <tr><td>12</td><td>—</td><td>10</td></tr> </table>	8	—	10	23	—	8	17	—	7	12	—	10	35	● 井原	○ 倉敷古城池 53	<table border="1"> <tr><td>14</td><td>—</td><td>7</td></tr> <tr><td>15</td><td>—</td><td>7</td></tr> <tr><td>15</td><td>—</td><td>9</td></tr> <tr><td>9</td><td>—</td><td>10</td></tr> </table>	14	—	7	15	—	7	15	—	9	9	—	10	33	● 笠岡商業																
8	—	10																																													
23	—	8																																													
17	—	7																																													
12	—	10																																													
14	—	7																																													
15	—	7																																													
15	—	9																																													
9	—	10																																													

ウインターカップ 2021  
 令和3年度 第74回全国高等学校バスケットボール選手権大会  
 美作地区予選会 結果

【男子の部】

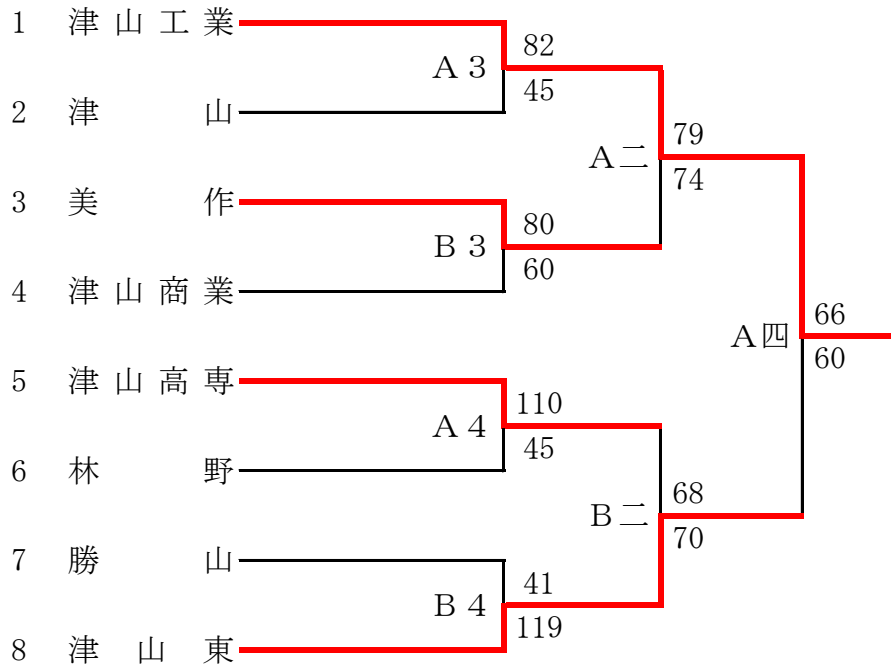

※県大会出場：作陽高校（県総体ベスト8以上）、津山工業

【女子の部】

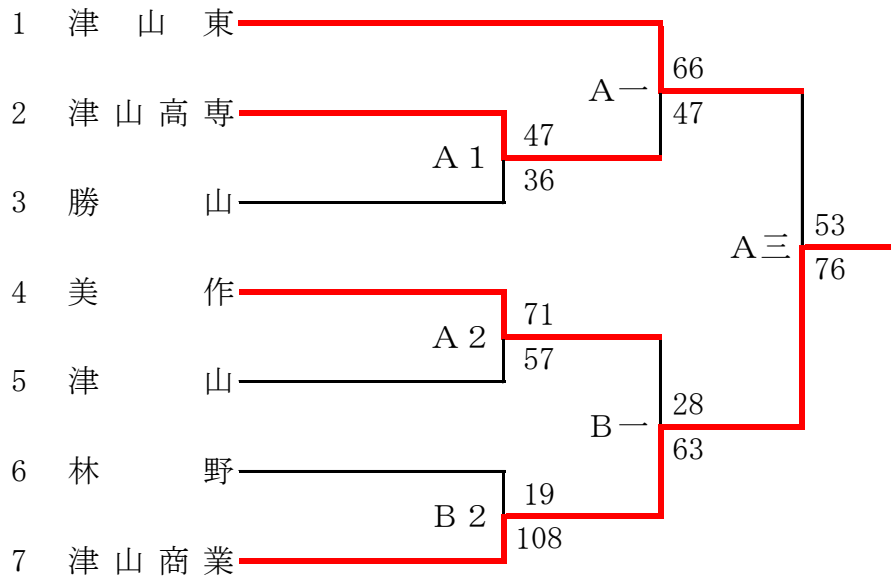

※県大会出場：作陽高校（県総体ベスト8以上）、津山商業

令和3年度 ウインターカップ2021 第74回全国高等学校バスケットボール選手権大会  
美作地区予選会

令和3年9月18日(土)・19日(日)

会場:津山高校 A・Bコート

【9月18日(土)】

《男子》

【A3】

○ 津山工業 82	<table border="1"><tr><td>13</td><td>—</td><td>12</td></tr><tr><td>25</td><td>—</td><td>3</td></tr><tr><td>17</td><td>—</td><td>11</td></tr><tr><td>27</td><td>—</td><td>19</td></tr></table>	13	—	12	25	—	3	17	—	11	27	—	19	45 津山 ●
13	—	12												
25	—	3												
17	—	11												
27	—	19												

《女子》

【A1】

○ 津山高専 47	<table border="1"><tr><td>9</td><td>—</td><td>12</td></tr><tr><td>4</td><td>—</td><td>9</td></tr><tr><td>16</td><td>—</td><td>7</td></tr><tr><td>18</td><td>—</td><td>8</td></tr></table>	9	—	12	4	—	9	16	—	7	18	—	8	36 勝山 ●
9	—	12												
4	—	9												
16	—	7												
18	—	8												

【B3】

○ 美作 80	<table border="1"><tr><td>24</td><td>—</td><td>10</td></tr><tr><td>17</td><td>—</td><td>19</td></tr><tr><td>22</td><td>—</td><td>17</td></tr><tr><td>17</td><td>—</td><td>14</td></tr></table>	24	—	10	17	—	19	22	—	17	17	—	14	60 津山商業 ●
24	—	10												
17	—	19												
22	—	17												
17	—	14												

【A2】

○ 美作 71	<table border="1"><tr><td>17</td><td>—</td><td>9</td></tr><tr><td>15</td><td>—</td><td>17</td></tr><tr><td>20</td><td>—</td><td>17</td></tr><tr><td>19</td><td>—</td><td>14</td></tr></table>	17	—	9	15	—	17	20	—	17	19	—	14	57 津山 ●
17	—	9												
15	—	17												
20	—	17												
19	—	14												

【A4】

○ 津山高専 110	<table border="1"><tr><td>19</td><td>—</td><td>12</td></tr><tr><td>35</td><td>—</td><td>12</td></tr><tr><td>36</td><td>—</td><td>6</td></tr><tr><td>20</td><td>—</td><td>15</td></tr></table>	19	—	12	35	—	12	36	—	6	20	—	15	45 林野 ●
19	—	12												
35	—	12												
36	—	6												
20	—	15												

【B2】

● 林野 19	<table border="1"><tr><td>4</td><td>—</td><td>24</td></tr><tr><td>6</td><td>—</td><td>27</td></tr><tr><td>3</td><td>—</td><td>26</td></tr><tr><td>6</td><td>—</td><td>31</td></tr></table>	4	—	24	6	—	27	3	—	26	6	—	31	108 津山商業 ○
4	—	24												
6	—	27												
3	—	26												
6	—	31												

【B4】

● 勝山 41	<table border="1"><tr><td>10</td><td>—</td><td>25</td></tr><tr><td>9</td><td>—</td><td>32</td></tr><tr><td>11</td><td>—</td><td>35</td></tr><tr><td>11</td><td>—</td><td>27</td></tr></table>	10	—	25	9	—	32	11	—	35	11	—	27	119 津山東 ○
10	—	25												
9	—	32												
11	—	35												
11	—	27												

● 0	<table border="1"><tr><td>—</td><td>—</td><td>—</td></tr><tr><td>—</td><td>—</td><td>—</td></tr><tr><td>—</td><td>—</td><td>—</td></tr><tr><td>—</td><td>—</td><td>—</td></tr></table>	—	—	—	—	—	—	—	—	—	—	—	—	0 ●
—	—	—												
—	—	—												
—	—	—												
—	—	—												

【9月19日(日)】

《男子》

【A二】

○ 津山工業 79	<table border="1"><tr><td>22</td><td>—</td><td>14</td></tr><tr><td>22</td><td>—</td><td>14</td></tr><tr><td>27</td><td>—</td><td>19</td></tr><tr><td>8</td><td>—</td><td>27</td></tr></table>	22	—	14	22	—	14	27	—	19	8	—	27	74 美作 ●
22	—	14												
22	—	14												
27	—	19												
8	—	27												

《女子》

【A一】

○ 津山東 66	<table border="1"><tr><td>16</td><td>—</td><td>9</td></tr><tr><td>20</td><td>—</td><td>12</td></tr><tr><td>10</td><td>—</td><td>17</td></tr><tr><td>20</td><td>—</td><td>9</td></tr></table>	16	—	9	20	—	12	10	—	17	20	—	9	47 津山高専 ●
16	—	9												
20	—	12												
10	—	17												
20	—	9												

【B二】

● 津山高専 68	<table border="1"><tr><td>17</td><td>—</td><td>20</td></tr><tr><td>17</td><td>—</td><td>12</td></tr><tr><td>21</td><td>—</td><td>16</td></tr><tr><td>13</td><td>—</td><td>22</td></tr></table>	17	—	20	17	—	12	21	—	16	13	—	22	70 津山東 ○
17	—	20												
17	—	12												
21	—	16												
13	—	22												

【B一】

● 美作 28	<table border="1"><tr><td>6</td><td>—</td><td>25</td></tr><tr><td>7</td><td>—</td><td>15</td></tr><tr><td>6</td><td>—</td><td>19</td></tr><tr><td>9</td><td>—</td><td>4</td></tr></table>	6	—	25	7	—	15	6	—	19	9	—	4	63 津山商業 ○
6	—	25												
7	—	15												
6	—	19												
9	—	4												

【A四】

○ 津山工業 66	<table border="1"><tr><td>13</td><td>—</td><td>18</td></tr><tr><td>23</td><td>—</td><td>13</td></tr><tr><td>17</td><td>—</td><td>12</td></tr><tr><td>13</td><td>—</td><td>17</td></tr></table>	13	—	18	23	—	13	17	—	12	13	—	17	60 津山東 ●
13	—	18												
23	—	13												
17	—	12												
13	—	17												

【A三】

● 津山東 53	<table border="1"><tr><td>14</td><td>—</td><td>15</td></tr><tr><td>11</td><td>—</td><td>16</td></tr><tr><td>16</td><td>—</td><td>20</td></tr><tr><td>12</td><td>—</td><td>25</td></tr></table>	14	—	15	11	—	16	16	—	20	12	—	25	76 津山商業 ○
14	—	15												
11	—	16												
16	—	20												
12	—	25												